

# USER MANUAL

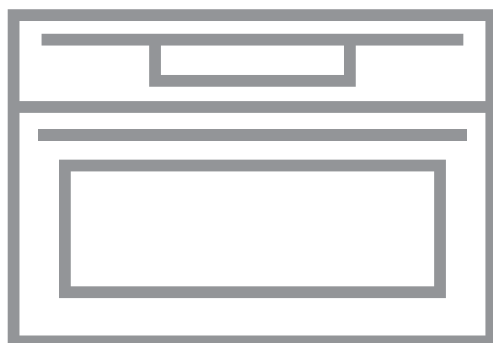

## CONTENTS

1. SAFETY INFORMATION.....	2
2. SAFETY INSTRUCTIONS.....	5
3. PRODUCT DESCRIPTION.....	8
4. OPERATING THE APPLIANCE.....	8
5. BEFORE FIRST USE.....	9
6. DAILY USE.....	10
7. CLOCK FUNCTIONS.....	13
8. USING THE ACCESSORIES.....	13
9. ADDITIONAL FUNCTIONS.....	14
10. HINTS AND TIPS.....	14
11. CARE AND CLEANING.....	21
12. TROUBLESHOOTING.....	22
13. ENERGY EFFICIENCY.....	24

## FOR PERFECT RESULTS

Thank you for choosing this AEG product. We have created it to give you impeccable performance for many years, with innovative technologies that help make life simpler – features you might not find on ordinary appliances. Please spend a few minutes reading to get the very best from it.

Visit our website for:



Get usage advice, brochures, trouble shooter, service and repair information:  
**[www.aeg.com/support](http://www.aeg.com/support)**



Register your product for better service:  
**[www.registeraeg.com](http://www.registeraeg.com)**



Buy Accessories, Consumables and Original spare parts for your appliance:  
**[www.aeg.com/shop](http://www.aeg.com/shop)**

## CUSTOMER CARE AND SERVICE

Always use original spare parts.

When contacting our Authorised Service Centre, ensure that you have the following data available: Model, PNC, Serial Number.

The information can be found on the rating plate.

 Warning / Caution-Safety information

 General information and tips

 Environmental information

Subject to change without notice.

### 1. SAFETY INFORMATION

Before the installation and use of the appliance, carefully read the supplied instructions. The

manufacturer is not responsible for any injuries or damage that are the result of incorrect installation or usage. Always keep the instructions in a safe and accessible location for future reference.

## 1.1 Children and vulnerable people safety

- This appliance can be used by children aged from 8 years and above and persons with reduced physical, sensory or mental capabilities or lack of experience and knowledge if they have been given supervision or instruction concerning the use of the appliance in a safe way and understand the hazards involved.
- Children between 3 and 8 years of age and persons with very extensive and complex disabilities shall be kept away from the appliance unless continuously supervised.
- Children of less than 3 years of age should be kept away from the appliance unless continuously supervised.
- Do not let children play with the appliance.
- Keep all packaging away from children and dispose of it appropriately.
- Keep children and pets away from the appliance when it operates or when it cools down. Accessible parts may become hot during use.
- If the appliance has a child safety device, it should be activated.
- Children shall not carry out cleaning and user maintenance of the appliance without supervision.

## 1.2 General Safety

- Only a qualified person must install this appliance and replace the cable.
- **WARNING:** The appliance and its accessible parts become hot during use. Care should be taken to avoid touching heating elements.
- Always use oven gloves to remove or put in accessories or ovenware.

- Before carrying out any maintenance, disconnect the appliance from the power supply.
- **WARNING:** Ensure that the appliance is switched off before replacing the lamp to avoid the possibility of electric shock.
- Do not use the appliance before installing it in the built-in structure.
- Do not use a steam cleaner to clean the appliance.
- Do not use harsh abrasive cleaners or sharp metal scrapers to clean the glass door since they can scratch the surface, which may result in shattering of the glass.
- If the mains power supply cable is damaged, it must be replaced by the manufacturer, its Authorised Service Centre or similarly qualified persons to avoid an electrical hazard.
- Do not activate the appliance when it is empty. Metal parts inside the cavity can create electric arcing.
- Metallic containers for food and beverages are not allowed during microwave cooking. This requirement is not applicable if the manufacturer specifies size and shape of metallic containers suitable for microwave cooking.
- If the door or door seals are damaged, the appliance must not be operated until it has been repaired by a qualified person.
- Only a qualified person can carry out any service or repair operation that involves the removal of a cover which gives protection against exposure to microwave energy.
- Do not heat liquids and other foods in sealed containers. They are liable to explode.
- Use only utensils that are suitable for use in microwave ovens.
- When heating food in plastic or paper containers, keep an eye on the appliance due to the possibility of ignition.
- The appliance is intended for heating food and beverages. Drying of food or clothing and heating of

warming pads, slippers, sponges, damp cloth and similar may lead to risk of injury, ignition or fire.

- If smoke is emitted, switch off or unplug the appliance and keep the door closed in order to stifle any flames.
- Microwave heating of beverages can result in delayed eruptive boiling. Care must be taken when handling the container.
- The contents of feeding bottles and baby food jars shall be stirred or shaken and the temperature checked before consumption, in order to avoid burns.
- Eggs in their shell and whole hard-boiled eggs should not be heated in the appliance since they may explode, even after microwave heating has ended.
- The appliance should be cleaned regularly and any food deposits removed.
- Failure to maintain the appliance in a clean condition could lead to deterioration of the surface that could adversely affect the life of the appliance and possibly result in a hazardous situation.

## 2. SAFETY INSTRUCTIONS

### 2.1 Installation



#### **WARNING!**

Only a qualified person must install this appliance.

- Remove all the packaging.
- Do not install or use a damaged appliance.
- Follow the installation instructions supplied with the appliance.
- Always take care when moving the appliance as it is heavy. Always use safety gloves and enclosed footwear.
- Do not pull the appliance by the handle.
- Keep the minimum distance from other appliances and units.
- Install the appliance in a safe and suitable place that meets installation requirements.
- The appliance is equipped with an electric cooling system. It must be operated with the electric power supply.

### 2.2 Electrical connection



#### **WARNING!**

Risk of fire and electric shock.

- All electrical connections should be made by a qualified electrician.
- The appliance must be earthed.
- Make sure that the parameters on the rating plate are compatible with the electrical ratings of the mains power supply.
- Always use a correctly installed shockproof socket.
- Do not use multi-plug adapters and extension cables.
- Make sure not to cause damage to the mains plug and to the mains cable. Should the mains cable need to be replaced, this must be carried out by our Authorised Service Centre.
- Do not let mains cables touch or come near the appliance door or the

niche below the appliance, especially when it operates or the door is hot.

- The shock protection of live and insulated parts must be fastened in such a way that it cannot be removed without tools.
- Connect the mains plug to the mains socket only at the end of the installation. Make sure that there is access to the mains plug after the installation.
- If the mains socket is loose, do not connect the mains plug.
- Do not pull the mains cable to disconnect the appliance. Always pull the mains plug.
- Use only correct isolation devices: line protecting cut-outs, fuses (screw type fuses removed from the holder), earth leakage trips and contactors.
- The electrical installation must have an isolation device which lets you disconnect the appliance from the mains at all poles. The isolation device must have a contact opening width of minimum 3 mm.
- This appliance complies with the E.E.C. Directives.

### 2.3 Use



#### **WARNING!**

Risk of injury, burns and electric shock or explosion.

- This appliance is for household use only.
- Do not change the specification of this appliance.
- Make sure that the ventilation openings are not blocked.
- Do not let the appliance stay unattended during operation.
- Deactivate the appliance after each use.
- Be careful when you open the appliance door while the appliance is in operation. Hot air can release.
- Do not operate the appliance with wet hands or when it has contact with water.
- Do not apply pressure on the open door.
- Do not use the appliance as a work surface or as a storage surface.

- Open the appliance door carefully. The use of ingredients with alcohol can cause a mixture of alcohol and air.
- Do not let sparks or open flames to come in contact with the appliance when you open the door.
- Do not put flammable products or items that are wet with flammable products in, near or on the appliance.
- Do not use microwave function to preheat the oven.



#### **WARNING!**

Risk of damage to the appliance.

- To prevent damage or discoloration to the enamel:
  - do not put aluminium foil directly on the bottom of cavity of the appliance.
  - do not put water directly into the hot appliance.
  - do not keep moist dishes and food in the appliance after you finish the cooking.
  - be careful when you remove or install the accessories.
- Discoloration of the enamel or stainless steel has no effect on the performance of the appliance.
- Use a deep pan for moist cakes. Fruit juices cause stains that can be permanent.
- This appliance is for cooking purposes only. It must not be used for other purposes, for example room heating.
- Always cook with the oven door closed.
- If the appliance is installed behind a furniture panel (e.g. a door) make sure the door is never closed when the appliance is in operation. Heat and moisture can build up behind a closed furniture panel and cause subsequent damage to the appliance, the housing unit or the floor. Do not close the furniture panel until the appliance has cooled down completely after use.

## 2.4 Care and cleaning



### **WARNING!**

Risk of injury, fire, or damage to the appliance.

- Before maintenance, deactivate the appliance and disconnect the mains plug from the mains socket.
- Make sure the appliance is cold. There is the risk that the glass panels can break.
- Replace immediately the door glass panels when they are damaged. Contact the Authorised Service Centre.
- Make sure the cavity and the door are wiped dry after each use. Steam produced during the operation of the appliance condensates on cavity walls and can cause corrosion.
- Clean regularly the appliance to prevent the deterioration of the surface material.
- Fat and food remaining in the appliance can cause fire and electric arcing when the microwave function operates.
- Clean the appliance with a moist soft cloth. Only use neutral detergents. Do not use any abrasive products, abrasive cleaning pads, solvents or metal objects.
- If you use an oven spray, follow the safety instruction on it's packaging.
- Do not clean the catalytic enamel (if applicable) with any kind of detergent.

## 2.5 Internal lighting



### **WARNING!**

Risk of electric shock.

- The type of light bulb or halogen lamp used for this appliance is for household appliances only. Do not use it for house lighting.
- Before replacing the lamp, disconnect the appliance from the power supply.
- Only use lamps with the same specifications.

## 2.6 Service

- To repair the appliance contact the Authorised Service Centre.
- Use original spare parts only.

## 2.7 Disposal



### **WARNING!**

Risk of injury or suffocation.

- Disconnect the appliance from the mains supply.
- Cut off the mains electrical cable close to the appliance and dispose of it.
- Remove the door catch to prevent children or pets from becoming trapped in the appliance.

## 3. PRODUCT DESCRIPTION

### 3.1 General overview

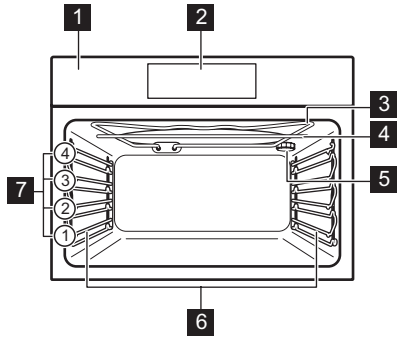

- 1** Control panel
- 2** Electronic programmer
- 3** Heating element
- 4** Microwave generator
- 5** Lamp
- 6** Shelf support, removable
- 7** Shelf positions

### 3.2 Accessories

For cookware, cake tins, roasts.

#### Wire shelf

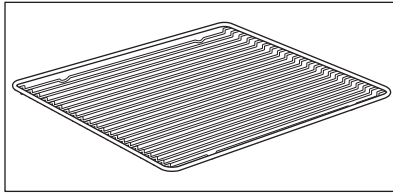

## 4. OPERATING THE APPLIANCE

### 4.1 Control panel

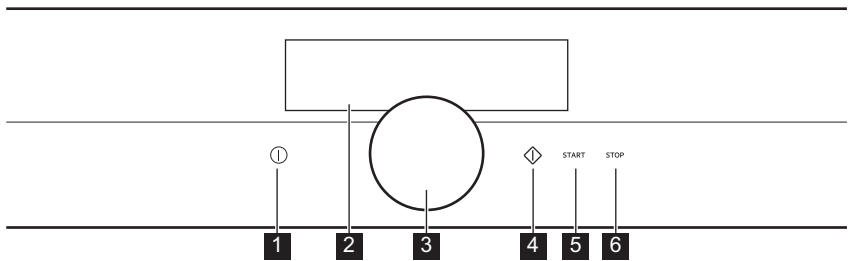

Function	Comment
<b>1</b> On / Off	To turn the appliance on and off.
<b>2</b> Display	Shows the current settings of the appliance.



Function	Comment
3 Rotary knob	To adjust the settings and navigate through the menu. Press ① to turn the appliance on. Hold the rotary knob to turn on the setting screen. Hold and turn the rotary knob to navigate through the menu. Hold and press the rotary knob to confirm a setting or enter the selected submenu. To return to the previous menu find the option Back in the menu list or confirm a selected setting.
4 Microwave function	Microwave Quickstart (1000W; 30 sec). You can turn it on also when the appliance is off.
5 START	To turn on selected function.
6 STOP	To turn off selected function.

## 4.2 Display

After turning on, the display shows the heating function mode.



The display with maximum number of functions set:

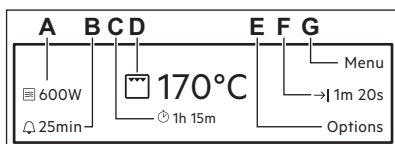

- A. Microwave power
- B. Reminder
- C. Up Timer
- D. Heating function and temperature
- E. Options or Time of Day
- F. Duration time and End time of a function
- G. Menu

## 5. BEFORE FIRST USE



**WARNING!**  
Refer to Safety chapters.

### 5.1 Initial Cleaning

Remove all accessories and removable shelf supports from the oven.

Refer to "Care and cleaning" chapter.

Clean the oven and the accessories before the first use.

Put the accessories and the removable shelf supports back to their initial position.

### 5.2 First Connection

After the first connection the software version will appear for 7 seconds.

You have to set the language, the Display Brightness and the Time of Day.

## 6. DAILY USE



### WARNING!

Refer to Safety chapters.

### 6.1 Heating Functions

Turning the heating functions on and off.

1. Turn on the oven.
  2. Hold the rotary knob.
- The last used function is underlined.
3. Press the rotary knob to enter the submenu and turn it to select a heating function.

4. Press the rotary knob to confirm.
5. Set the temperature and confirm.
6. Press **START**. Some functions contain a sequence of pop-ups. Press the rotary knob to go to the next pop-up. After the last confirmation the function starts.

To turn off a function press **STOP**.



The lamp may turn off automatically at a temperature below 60 °C during some oven functions.

### Heating functions: Microwave

Do not preheat the oven when you use microwave functions.

Microwave function creates the heat directly in the food.

Heating function	Application
Microwave	Microwave heating at medium-low power (100 - 600 W). To heat pre-prepared meals. To cook vegetables and fish.
Microwave Max	Microwave heating at high power (700 - 1000 W). Creates the heat directly in the food. To heat drinks and soups.
Grill	To grill flat food and to toast bread.
Grill + MW	Function with MW boost. To grill flat food and to toast bread.
Defrost	Function with MW boost. To defrost meat, fruits and vegetables.

### 6.2 Menu - overview



## Menu

Menu item	Application
Assisted Cooking	Contains a list of automatic programmes.
Basic Settings	Used to set the appliance configuration.

## Submenu for: Basic Settings

Submenu	Description
Child Lock	When the Child Lock is on, the oven cannot be activated accidentally. You can activate and deactivate this function via Basic Setting Menu. Once activated, Child Lock appears on the display when you turn on the oven. To enable the oven use, choose the code letters with the rotary knob in the following order: A B C.
Time Extension	To extend predefined cooking time. Note that it is available only for some of the heating functions.
Setup	To set the oven configuration.
Service	Shows the software version and configuration.

## Submenu for: Setup

Submenu	Description
Language	Sets the language for the display.
Time of Day	Sets the current time and date.
Key Tones	Activates and deactivates the tone of the touch fields. It is not possible to deactivate the tone of the ON / OFF and STOP.
Alarm/Error Tones	Activates and deactivates the alarm tones.
Buzzer Volume	Adjusts the volume of press-tones and signals by degrees.
Display Brightness	Adjusts the display brightness by degrees.

## Submenu for: Service

Submenu	Description
DEMO	Activation / deactivation code: 2468
Show Licenses	Information about licenses.
Show Software Version	Information about software version.
Factory Settings	Reset to factory settings.

## Submenu for: Assisted Cooking

Every dish in this submenu has a proposed function, microwave power and temperature. You can change those settings manually.

For some of the dishes You can also choose way of cooking:

- Weight Automatic

Defrost food	Meat
	Poultry
	Fish
	Bread
Reheating	

Cook	Meat	Roast beef
		Beef fillet
		Pork loin
		Saddle of lamb
		Veal loin
		Whole chicken
	Whole fish	
	Side dishes	Potatoes
		Rice
	Oven dishes	Lasagne
		Potato gratin

## 6.3 Options

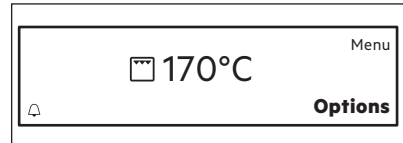



Options	Description
Timer Settings	Contains a list of clock functions.
Set + Go	To set a function and turn it on later. Once set, the message "Set&Go active" appears on the display. Press Start to turn it on. When this function is active the message disappears from the display and the oven starts to work. Note that it is available only for some of the heating functions and if Duration / End Time is set.

## 6.4 Residual heat

When you turn off the oven, the display shows the residual heat. You can use the heat to keep the food warm.

# 7. CLOCK FUNCTIONS

## 7.1 Timer Settings

Clock function	Application
 Up Timer	Automatically monitors how long the function operates. The visibility of the Up Timer can be turned on and off.
 Duration	To set the length of an operation. <sup>1)</sup>
 End Time	To set the switch-off time for a heating function. This option is available only when the Duration is set. Use the functions Duration and End Time at the same time to automatically turns on and off the oven on a given time later. <sup>1)</sup> This function is not available when the Microwave function operates.

<sup>1)</sup> Maximum 23 h 59 min

# 8. USING THE ACCESSORIES



**WARNING!**  
Refer to Safety chapters.

## 8.1 Inserting the accessories

Use only suitable cookware and material.



**WARNING!**  
Refer to "Hints and tips" chapter, Microwave suitable cookware and materials.

Wire shelf:

Push the shelf between the guide bars of the shelf support and make sure that the feet point down.

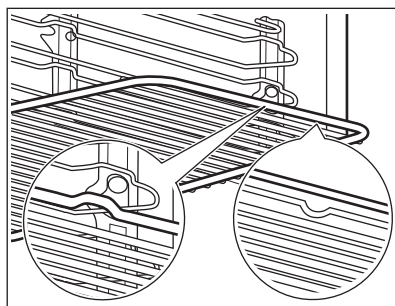



Small indentation at the top increase safety. The indentations are also anti-tip devices. The high rim around the shelf prevents cookware from slipping of the shelf.

## 9. ADDITIONAL FUNCTIONS

### 9.1 Automatic Switch-off

For safety reasons the oven turns off automatically after some time, if a heating function works and you do not change any settings.

 (°C)	 (h)
30 - 115	12.5
120 - 195	8.5

 (°C)	 (h)
200 - 230	5.5

The Automatic Switch-off does not work with the functions: Light, Duration, End Time.

### 9.2 Cooling fan

When the oven operates, the cooling fan turns on automatically to keep the surfaces of the oven cool. If you turn off the oven, the cooling fan can continue to operate until the oven cools down.

## 10. HINTS AND TIPS



**WARNING!**  
Refer to Safety chapters.



The temperature and baking times in the tables are guidelines only. They depend on the recipes and the quality and quantity of the ingredients used.

### 10.1 Cooking recommendations

Your oven may bake or roast differently to the oven you had before. The tables below show recommended settings for temperature, cooking time and shelf position for specific types of the food.

If you cannot find the settings for a special recipe, look for the similar one.

### 10.2 Microwave recommendations

Place the food on a plate on the bottom of the cavity.

Turn or stir the food halfway through the defrosting and cooking time.

Cover the food for cooking and reheating.

Put the spoon to the bottle or glass when heating drinks to ensure better heat distribution.

Put the food into the oven without any packaging. The packaged ready meals can be put into the oven only when the packaging is microwave safe (check information on the packaging).

#### Microwave cooking

Cook food covered. If you want to keep a crust cook food without a cover.

Do not overcook the dishes by setting the power and time too high. The food can dry out, burn or cause fire.

Do not use the oven to cook eggs or snails in their shells, because they can burst. Pierce the yolk of fried egg before reheating it.

Pierce food with skin or peel with a fork several times before cooking.

Cut vegetables into similar-sized pieces.

Stir liquid dishes from time to time.

Stir the food before serving.

After you turn off the oven, take the food out and let it stand for a few minutes.

#### Microwave defrosting

Put the frozen, unwrapped food on a small upturned plate with a container

below it, or on a defrosting rack or plastic sieve so that the defrosting liquid can run off.



To cook fruit and vegetables without defrosting them first, you can use a higher microwave power.

Remove defrosted pieces subsequently.

### 10.3 Microwave suitable cookware and materials

For the microwave use only suitable cookware and materials. Use below table as a reference.

Cookware / Material				
Ovenproof glass and porcelain with no metal components, e.g. heat-proof glass	✓	✓	✓	✓
Non-ovenproof glass and porcelain without any silver, gold, platinum or other metal decorations	✓	X	X	X
Glass and glass ceramic made of ovenproof / frost-proof material	✓	✓	✓	✓
Ceramic and earthenware without any quartz or metal components and glazes which contain metal	✓	✓	X	X
Ceramic, porcelain and earthenware with unglazed bottom or with small holes, e.g. on handles	X	X	X	X
Heat-resistant plastic up to 200 °C (please always check the plastic container specification before use)	✓	✓	X	X
Cardboard, paper	✓	X	X	X
Clingfilm	✓	X	X	X
Roasting film with microwave safe closure (please always check the film specification before use)	✓	✓	X	X
Roasting dishes made of metal, e.g. enamel, cast iron	X	X	✓	X

Cookware / Material				
Baking tins, black lacquer or silicon-coated (please always check the baking tins specification before use)	X	X	✓	X
Wire shelf	X	X	✓	✓
Cookware for microwave use, e.g. crisp pan	X	✓	X	X

## 10.4 Bread Baking





Preheating is not recommended.

Preheat the empty oven before cooking.

Put a pan on the first shelf position to collect fat.

## 10.5 Grill

Grill only thin pieces of meat or fish.







 GRILL			
 Use the first shelf position.			
	 (°C)	 (min)	
		1st side	2nd side
Roast beef, medium	210 - 230	30 - 40	30 - 40
Beef fillet, medium	230	20 - 30	20 - 30
Pork loin	210 - 230	30 - 40	30 - 40
Veal loin	210 - 230	30 - 40	30 - 40
Saddle of lamb	210 - 230	25 - 35	20 - 35
Whole fish, 0.5 - 1 kg	210 - 230	15 - 30	15 - 30









## 10.6 Microwave cooking







Tips for Microwave		
Cooking / Defrosting results	Possible cause	Remedy
The food is too dry.	Power was too high. Cooking time was too long.	Set lower power or/and shorter cooking time.
The food is not defrosted, cold or underdone after cooking time ends.	Cooking time was too short.	Set longer cooking time. Do not increase microwave power.
The food is overheated at the edges, but underdone in the middle.	Microwave power was too high.	Set lower power and longer cooking time.

### Defrost







 MEAT / FISH			
 Set power for 100 W unless specified otherwise.			
	 (kg)	 (min)	 Standing time (min)
Steak	0.2	5 - 7	5 - 10
Minced meat, set 200 W	0.5	7 - 8	5 - 10
Chicken	1	30 - 35	10 - 20
Chicken breast	0.15	5 - 9	10 - 15
Chicken legs	0.15	5 - 9	10 - 15
Whole fish	0.5	10 - 15	5 - 10
Fish fillet	0.5	12 - 15	5 - 10







 <b>DAIRY PRODUCTS</b>				
 <b>Set power for 100 W.</b>				
	 (kg)	 (min)	 <b>Standing time (min)</b>	
Butter	0.25	4 - 6	5 - 10	
Grated cheese	0.2	2 - 4	10 - 15	





  







 <b>CAKES / PASTRIES</b>				
 <b>Set power for 200 W unless specified otherwise.</b>				
		 (min)	 <b>Standing time (min)</b>	
Yeast cake	1 piece	2 - 3	15 - 20	
Cheesecake, set 100 W	1 piece	2 - 4	15 - 20	
Dry cake	1 piece	2 - 4	15 - 20	
Bread	1 kg	15 - 18	5 - 10	
Sliced bread	0.2 kg	3 - 5	5 - 10	
Bread rolls	4 pieces	2 - 4	2 - 5	







  

 <b>FRUIT</b>				
	 (kg)	 (W)	 (min)	 <b>Standing time (min)</b>
Fruit	0.25	100	5 - 10	10 - 15

 REHEATING				
		 POWER (W)	 (min)	 Standing time (min)
Baby food in jars	0.2 kg	300	1 - 2	-
Baby milk, put a spoon into the bottle	180 ml	600	0:20 - 0:40	-
Milk	200 ml	1000	1 - 1:30	-
Water	200 ml	1000	1:30 - 2	-
Sauce	200 ml	600	1 - 3	-
Soup	300 ml	600	3 - 5	-
Ready frozen meals	0.5 kg	400	10 - 15	2 - 5
Convenience food	0.5 kg	600	6 - 9	2 - 5

 MELTING				
	 (kg)	 POWER (W)	 (min)	
Chocolate / Chocolate icing	0.15	300	2 - 4	
Butter	0.1	400	0:30 - 1:30	







 COOKING				
		 POWER (W)	 (min)	 Standing time (min)
Whole fish	0.5 kg	500	8 - 10	2 - 5
Fish fillet	0.5 kg	400	4 - 7	2 - 5
Vegetables, fresh	0.5 kg + 50 ml of water	600	5 - 15	-
Vegetables, frozen	0.5 kg + 50 ml of water	600	10 - 20	-
Jacket potatoes	0.5 kg	600	7 - 10	-

 COOKING				
		 POWER (W)	 (min)	 Standing time (min)
Rice	0.2 kg + 400 ml of water	600	15 - 18	-
Popcorn	-	1000	1:30 - 3	-

**Microwave Combi function**







Combine functions: Grill and Microwave.

Use this function to cook food in a shorter time and to brown it.









	 (kg)		 POWER (W)	 (°C)	 (min)	 Standing time (min)
Chicken, half, use the second shelf position	0.55 x 2 pieces	Round glass dish, Ø 26 cm	300	220	40	5
Au gratin potatoes, use the second shelf position	1	Round glass dish	300	200	40	10
Roast pork neck, use the first shelf position	1	Glass dish with strainer	300	200	70	10

**10.7 Information for test institutes**

Tests according to IEC 60705.

MICROWAVE FUNCTION						
 Use wire shelf unless otherwise specified.						
	 POWER (W)	 (kg)		 (min)		
Sponge cake	600	0.475	Bottom	8 - 9		Turn container around by 1/4, halfway through the cooking time.
Meatloaf	400	0.9	1	25 - 27		Turn container around by 1/4, halfway through the cooking time.
Egg custard	300	1	2	30 - 33		Turn container around by 1/4, halfway through the cooking time.
Meat de-frosting	200	0.5	Bottom	8 - 12		Turn the meat upside down halfway through the cooking time.

Tests according to IEC 60705.



MICROWAVE COMBI FUNCTION							
 Use the wire shelf.							
		 POWER (W)	 (°C)		 (min)		
Potato gratin, 1.1 kg	True Fan Cooking + MW	400	160	1	38 - 42		Turn container around by 1/4, halfway through the cooking time.
Chicken, 1.1 kg	Grill + Fan + MW	400	200	1	40 - 45		Put the meat in round glass container and turn it upside down halfway through the cooking time.

## 11. CARE AND CLEANING



**WARNING!**  
Refer to Safety chapters.

## 11.1 Notes on cleaning

	Clean the front of the oven with a soft cloth with warm water and a mild cleaning agent.
<b>Cleaning Agents</b>	To clean metal surfaces, use a dedicated cleaning agent.
	Clean stubborn stains with a special oven cleaner.
	Clean the oven cavity after each use. Fat accumulation or other food remains may cause fire.
<b>Everyday Use</b>	Dry the cavity with a soft cloth after each use.
	Clean the cavity ceiling carefully from food residuals and fat.
	Clean all accessories after each use and let them dry. Use a soft cloth with warm water and a cleaning agent. Do not clean the accessories in a dishwasher.
<b>Accessories</b>	Do not clean the non-stick accessories using aggressive agents, sharp-edged objects or in a dishwasher

## 11.2 Removing the shelf supports

Before maintenance, make sure that the oven is cool. There is a risk of burns.

To clean the oven, remove the shelf supports.

1. Pull carefully the supports up and out of the front catch.

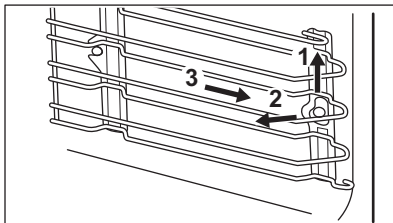

2. Pull the front end of the shelf support away from the side wall.
3. Pull the supports out of the rear catch.

Install the shelf supports in the opposite sequence.

## 11.3 Replacing the lamp



### WARNING!

Risk of electric shock.  
The lamp can be hot.

1. Turn off the oven.  
Wait until the oven is cooled down.
2. Disconnect the oven from the mains.
3. Put a cloth on the bottom of the cavity.



### CAUTION!

Always hold the halogen lamp with a cloth to prevent grease residue from burning on the lamp.

## The top lamp

1. Turn the lamp glass cover to remove it.
2. Clean the glass cover.
3. Replace the lamp with a suitable 300 °C heat-resistant lamp.
4. Install the glass cover.

## 12. TROUBLESHOOTING



### WARNING!

Refer to Safety chapters.

## 12.1 What to do if...

Problem	Possible cause	Remedy
You cannot activate or operate the oven.	The oven is not connected to an electrical supply or it is connected incorrectly.	Check if the oven is correctly connected to the electrical supply (refer to the connection diagram if available).
The oven does not heat up.	The oven is deactivated.	Activate the oven.
The oven does not heat up.	The clock is not set.	Set the clock.
The oven does not heat up.	The necessary settings are not set.	Make sure that the settings are correct.
The oven does not heat up.	The automatic switch-off is activated.	Refer to "Automatic switch-off".
The oven does not heat up.	The fuse is blown.	Make sure that the fuse is the cause of the malfunction. If the fuse is blown again and again, contact a qualified electrician.
The lamp does not operate.	The lamp is defective.	Replace the lamp.
The display prompts to set the Language.	There was a power cut longer than 3 days.	Refer to "Before first use" chapter.
The display prompts to set the Language.	The demo mode is activated.	Turn off demo mode in: Menu / Basic Settings / DEMO. Activation / deactivation code: 2468.
The display shows an error code that is not in this table.	There is an electrical fault.	<ul style="list-style-type: none"> <li>Deactivate the oven with the house fuse or the safety switch in the fuse box and activate it again.</li> <li>If the display shows the error code again, contact the Customer Care Department.</li> </ul>
Steam and condensation settle on the food and in the cavity of the oven.	You left the dish in the oven for too long.	Do not leave the dishes in the oven for longer than 15 - 20 minutes after the cooking process ends.

## 12.2 Service data

If you cannot find a solution to the problem yourself, contact your dealer or an Authorised Service Centre.

The necessary data for the service centre is on the rating plate. The rating plate is

on the front frame of the oven cavity. Do not remove the rating plate from the oven cavity.

**We recommend that you write the data here:**

Model (MOD.) .....

Product number (PNC) .....

Serial number (S.N.) .....

## 13. ENERGY EFFICIENCY

### 13.1 Energy saving



The oven contains features which help you save energy during everyday cooking.

Make sure that the oven door is closed properly when the oven operates. Do not open the door too often during cooking. Keep the door gasket clean and make sure it is well fixed in its position.

Use metal cookware to improve energy saving (only when you use a non-microwave function).

When possible, do not preheat the oven before cooking.

Keep breaks between baking as short as possible when you prepare a few dishes at one time.

#### Residual heat

If a programme with the Duration or End Time selection is activated and the cooking time is longer than 30 minutes,

the heating elements automatically turn off earlier in some oven functions.

The lamp continues to operate. When you turn off the oven, the display shows the residual heat. You can use that heat to keep the food warm.

When the cooking duration is longer than 30 minutes, reduce the oven temperature to minimum 3 - 10 minutes before the end of cooking. The residual heat inside the oven will continue to cook.

Use the residual heat to warm up other dishes.

#### Keep food warm

Choose the lowest possible temperature setting to use residual heat and keep a meal warm. The residual heat indicator or temperature appears on the display.

#### Cooking with the lamp off

Turn off the lamp during cooking. Turn it on only when you need it.

## 14. ENVIRONMENTAL CONCERNS

Recycle materials with the symbol . Put the packaging in relevant containers to recycle it. Help protect the environment and human health by recycling waste of electrical and electronic appliances. Do not dispose of

appliances marked with the symbol  with the household waste. Return the product to your local recycling facility or contact your municipal office.









[www.aeg.com/shop](http://www.aeg.com/shop)



867 335716-D-032020



**AEG**